

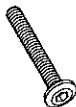



Child's Table & 2-Chairs Set Style # 521-2BL / PK





CAUTION: HARDWARE ASSEMBLY PACKAGE CONTAINS SMALL PARTS "ADULT ASSEMBLY REQUIRED"

A	B	C	
			x12
x1	x4	F	x4
D	E		x8
			x12





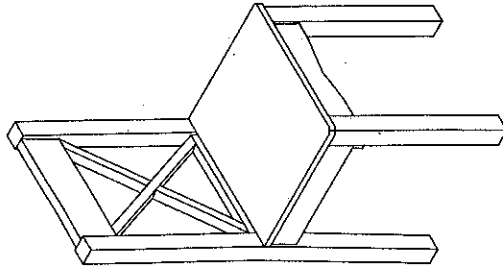
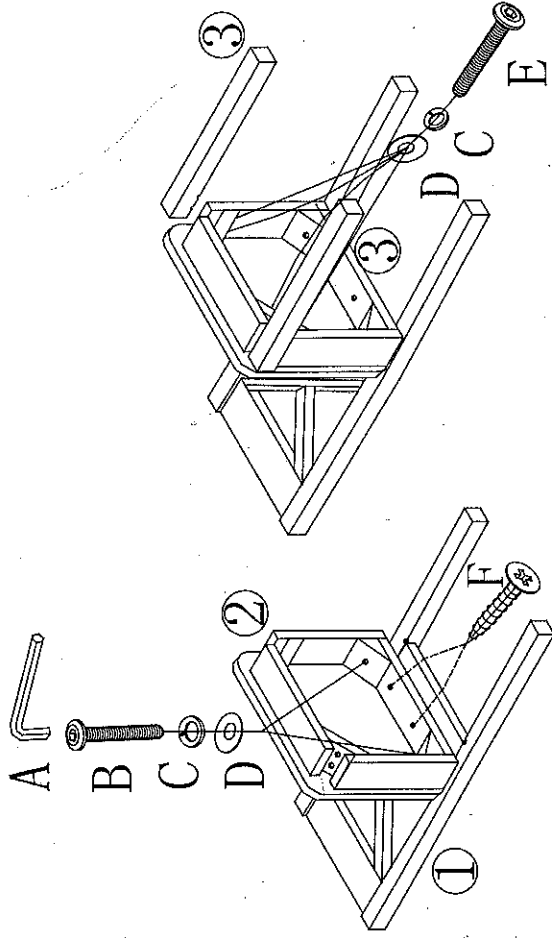

Any Questions, Please call us at
 Lipper International 1-800-243-3129
www.lipperinternational.com

IMPORTANT:

Please read the assembly instructions before beginning. Before assembling, prepare the tools in the shaded areas. Check the contents of the box and sort screws and other hardware

A	B	C	D	E	F
					
x1	x2	x6	x6	x4	x2



A	B	C	D	E	F
					
x1	x2	x6	x6	x4	x2

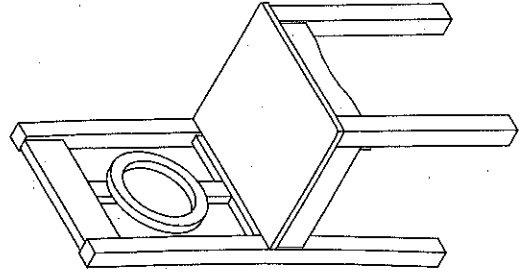
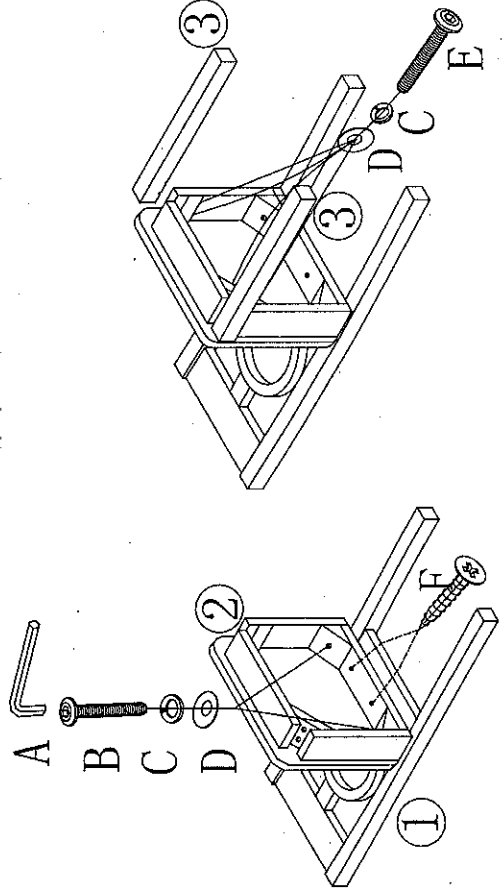

Lipper
 International Inc.
 Wallingford, CT 06492